



Characterization of Balanced Digital Components and Communication Paths



Agilent Technologies
Innovating the HP Way

This paper describes a method and a system for accurately and comprehensively characterizing the linear performance of balanced devices. It opens that way for higher speed devices and interconnects by providing a characterization technique with greater accuracy and flexibility than conventional approaches.

Outline

- Differential Devices
- Statement of Problem
- Unbalanced and Balanced Performance Parameters
- System Implementation
- Measurement Examples
- Conclusion

This paper on balanced device characterization will cover the following topics:

First we will review the characteristics of balanced devices to understand why they are used, and how frequency-domain measurements can be applied.

After that we will look at commonly used techniques for measuring these devices and their advantages and disadvantages.

Next we will consider a way of describing the behavior of balanced devices, and how this relates to a design methodology.

A system for characterizing balanced devices has been developed and will be briefly described.

Finally, before concluding, examples of measurements on balanced transmission lines will be discussed, and a variety of ways of representing the data will be shown.

Differential Device Topology

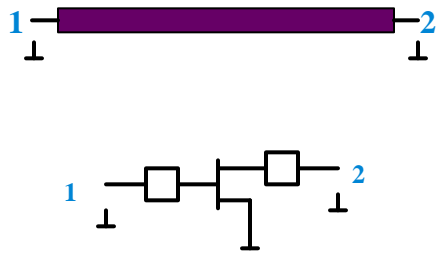

Unbalanced Device

- Signals referenced to ground

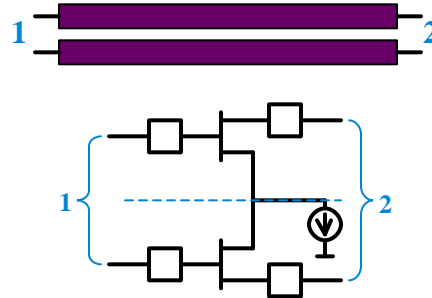

Differential Device

- Signals equal amplitude and anti-phase
- Also supports a common mode (in-phase) signal
- Virtual ground

An unbalanced, or single-ended, device has all of its signals referenced to a common ground potential.

A balanced device, by comparison, is composed of two nominally identical halves. Practically speaking, the signals on each side of the device can have any relative amplitude and phase relationship, but they can be decomposed into a differential-mode (anti-phase) component, and a common-mode (in-phase) component.

A balanced circuit operating in common-mode has no performance advantages over a single-ended circuit. The advantages of this topology come from operating the device in differential mode.

When a device is driven differentially, a virtual ground is established along its axis of symmetry. At the virtual ground, the potential at the operating frequency does not change with time regardless of the signal amplitude.

Performance Attributes of Differential Circuits

- **Noise Immunity from:**
 - Power Supplies
 - Hash from Adjacent Circuits
 - External EMI
- Even-Order Harmonic Suppression
- RF Grounding Quality Less Critical

Balanced circuits have been used for many years because of their desirable performance characteristics. They have been mostly used in lower frequency analog circuitry and digital devices, and much less so in RF and microwave applications.

One benefit of differential circuits is that they have good immunity from many sources of noise such as that from power supplies, adjacent circuitry, and other external sources that are coupled either electrically or electromagnetically. These noise sources tend to couple in the common-mode, and therefore cancel in differential mode.

Cancellation also occurs at even-harmonic frequencies since signals that are anti-phase at the fundamental frequency are in-phase at the even harmonics.

The quality of the virtual ground in a differential circuit is independent of the physical ground path. Therefore, differential devices can tolerate poor RF grounds better than unbalanced devices.

Statement of Problem

- Data Communication Systems Are Operating at **Higher Speeds**
- Data Rates Are Becoming **Microwave** in Nature
- Many Traditional Design & Measurement Techniques Can No Longer Be Applied
- Must Adopt **Microwave Techniques**

The demand for higher speed / higher bandwidth communication systems is seemingly insatiable.

As data rates become higher, and more importantly, as rise time become faster, these high speed signals become microwave in nature. This means that distributed effects become very important, and parasitic elements become increasingly significant.

As a result, it is increasingly important to reconsider the design and measurement techniques that are used. What sources of error are present in the measurements? What assumptions are inherent in the techniques being used?

There is a large body of knowledge in dealing with signals of such a high frequency. Applying microwave design and measurement techniques to traditional digital techniques can provide solutions for the development of the next generation of high speed devices.

Sources of Measurement Deficiencies

- TDR's Use A Scalar Calibration Technique
- Wideband Front-End in 'Scope Limits Its Dynamic Range

A TDR is a commonly used instrument for testing components such as transmission lines and interconnects. These instruments perform well up to some speed, but eventually their accuracy and dynamic range render them useless.

The calibration technique for TDR's is a scalar approach that corrects the response of the system, but not the sources of measurement error.

High speed front-ends on oscilloscopes must have very wide bandwidths to be able to follow a fast signal. However, wideband front-ends contain a large noise power. Therefore, the faster the TDR system, generally the poorer its dynamic range.

Advantages of Frequency Domain Measurements

- Superior **accuracy**
- Significantly better **dynamic range** (important for crosstalk and mode-conversion terms)
- Ability to **de-embed** fixtures and signal launchers
- Access to both **frequency and time** domain information (as vector quantities)
- Just a **single setup** for forward and reverse; transmission and reflection; unbalanced, differential-mode, common-mode, and mode-conversion terms
- No need for DUT to have DC **return path**
- No large **voltage steps** applied to DUT

By contrast, a VNA can provide excellent accuracy because the sources of measurement error are characterized during calibration, and a vector error correction is applied to the measured data.

The receiver in a VNA is a tuned circuit, and therefore can provide an exceptionally high dynamic range.

The data itself is vector data, not scalar data. Therefore with a VNA it is possible to de-embed fixtures and signal launches, and it is possible to translate the data from the frequency domain to the time domain.

The switching in the test set and the software capabilities available in balanced measurement solutions allow a complete characterization of a DUT with a one-time connection to the test system

Finally, the DUT is tested by applying lower-level RF signals. Therefore active devices do not need to have DC return paths as they must with a TDR, and no large voltage steps are applied to the DUT as they are with a TDR.

Approach

Although:

- Frequency-Domain Measurements Can Provide **Best Data**
- S-parameters Can **Fully Characterize** a Device

However:

- S-parameter Data Must Describe **Balanced Performance**
- Data Must Be Presented in a **Meaningful Format**

We have described why frequency-domain measurements can make very accurate and complete measurements on devices used for high speed data communication applications.

However, to be applicable the correct type of information must be provided to the user. First, the system must be able to characterize balanced devices, not only unbalanced devices. Second, the data must be put into the proper format to be meaningful to the user.

The remainder of this presentation will describe how these last two issues can be addressed.

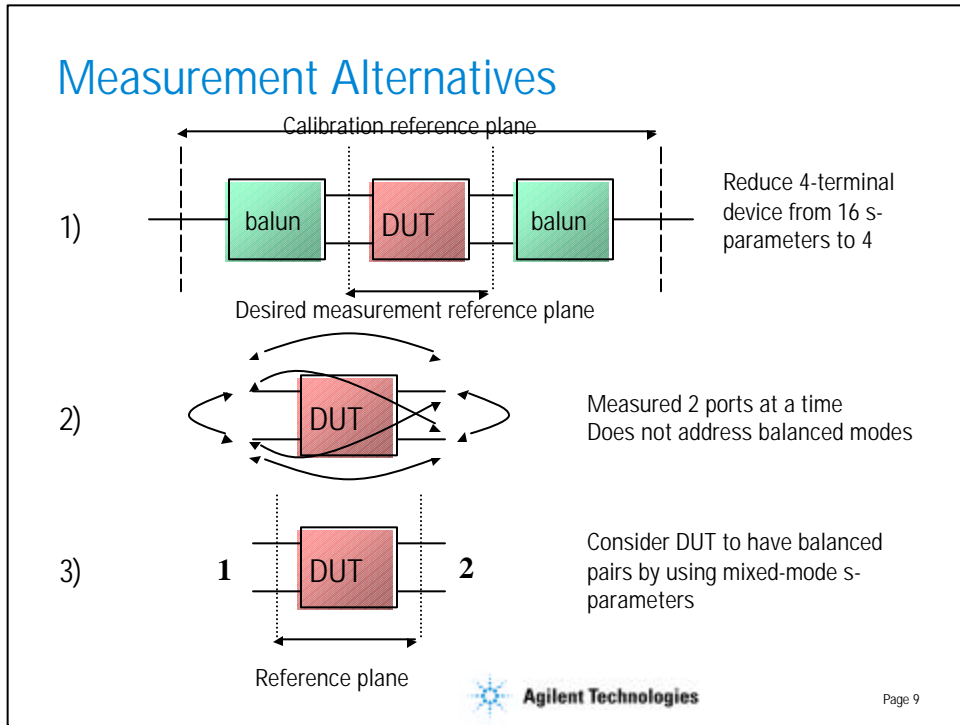

Typically there are two approaches that are used to measure balanced devices using a VNA. One is to convert each balanced port to a single-ended port using a balun, and measure that network on a single-ended VNA. One disadvantage to this approach is that it is inaccurate because the reference plane of the calibration is at the single-ended test port of the VNA, while the desired measurement reference plane is at the balanced port of the DUT. The balun in between is typically far from ideal and will degrade the accuracy of the measurement, particularly when used over a very wide bandwidth. The other disadvantage is that this approach is not comprehensive since, at best, it can only portray the pure differential mode of operation, not the other three modes.

Another method is to measure the balanced device as a single-ended multiport device. This can be a very time consuming process since multiple two port measurements are needed to fully characterize the device. In addition, it can be misleading since the single-ended data may not give a representative indication of the performance of the device when it operates in one of its balanced modes.

The method that is preferred for its accuracy, completeness, and ease of interpretation is to characterize the DUT using mixed-mode s-parameters such as measured on Agilent's balanced measurement solutions.

Unbalanced and Balanced Devices

- **Unbalanced: ports referenced to gnd (S-parameters)**



- **Balanced: ports are pairs (Mixed-Mode S-parameters)**



A multi-terminal device can be viewed in different ways, depending on how it is meant to be operated. For a device that is designed to be a single-ended four-port, its conventional four-port s-parameters can be measured and displayed.

In a balanced device, two terminals constitute a single port. Each balanced port will support both a common-mode and a differential-mode signal. This performance is described using mixed-mode s-parameters.

In the discussion that follows, we will go back and forth between single-ended and balanced device examples several times to compare and contrast the concepts.

Single-Ended S-Parameters

Conventional S-Parameters Answer the Question ...

If a single port of a device is **stimulated**,
what are the corresponding **responses** on all
ports of the device?



Let's compare what is meant by single-ended and mixed-mode s-parameters. Recall that with conventional single-ended s-parameters we are describing the performance of a device when it is stimulated on a single port, and the corresponding responses are observed on all of the ports.

Mixed-Mode S-Parameters

Mixed-Mode S-Parameters Answer the Question ...

If a balanced port of a device is **stimulated** with a common-mode or differential-mode signal,

what are the corresponding common-mode and differential-mode **responses** on all ports of the device?



The mixed-mode s-parameters concept is similar, except that instead of stimulating a single terminal of the DUT, with a balanced device we consider pairs of terminals to be stimulated in either a differential (anti-phase) or a common (in-phase) mode. With mixed-mode s-parameters we are asking, with a differential mode stimulus on a balanced port, what are the corresponding differential and common mode responses on all of the device ports? Likewise for a common mode stimulus, what are the differential and common mode responses?

Single-Ended S-Parameter Review

Single-Ended 4-Port

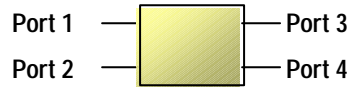

Voltage V_n
 Current I_n
 Impedance $Z_n = V_n / I_n$

| | Normalized Power Waves |
|----------|---|
| stimulus | $a_n = \frac{1}{2 \cdot \sqrt{\text{Re}\{Z_n\}}} (V_n + I_n \cdot Z_n)$ |
| response | $b_n = \frac{1}{2 \cdot \sqrt{\text{Re}\{Z_n\}}} (V_n - I_n \cdot Z_n)$ |

$$S = b/a$$



Page 13

We have looked at the intuitive description of mixed-mode s-parameters. Now let's look at a more mathematical description.

For a single-ended device, RF voltages and currents relative to a common ground can be defined at each terminal of the device. From these we can also define an impedance.

From the voltage, current, and impedance definitions, normalized power waves can be defined in stimulus and response. Stimulus power waves are defined as propagating into the DUT, and response power waves propagate away from the DUT.

The s-parameters are ratios of a response to a stimulus normalized power wave.

Single-Ended S-Matrix

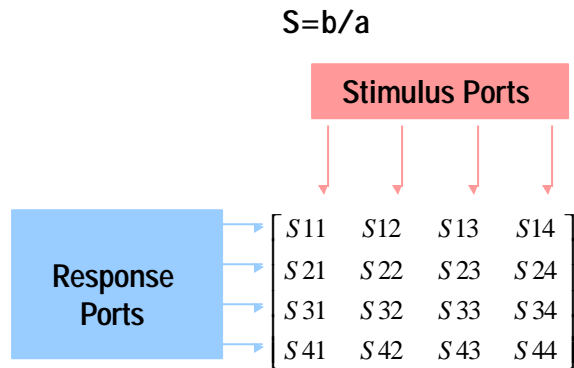

An s-parameter is defined as the ratio of two normalized power waves: the response divided by the stimulus. A full s-matrix describes every possible combination of a response divided by a stimulus.

The matrix is arranged in such a way that each column represents a particular stimulus condition, and each row represents a particular response condition.

Mixed-Mode S-Parameter Basics

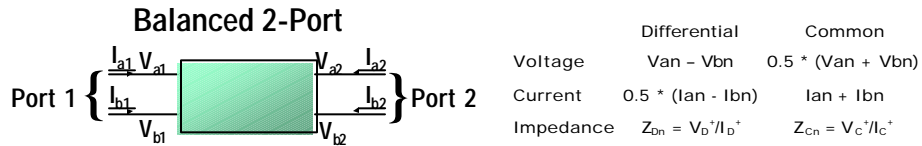

| | Normalized Power Waves | |
|----------|--|--|
| | Differential-Mode | Common-Mode |
| stimulus | $a_{dn} = \frac{1}{2 \cdot \sqrt{\text{Re}\{Z_{Dn}\}}} (V_{dn} + I_{dn} \cdot Z_{Dn})$ | $a_{cn} = \frac{1}{2 \cdot \sqrt{\text{Re}\{Z_{Cn}\}}} (V_{cn} + I_{cn} \cdot Z_{Cn})$ |
| response | $b_{dn} = \frac{1}{2 \cdot \sqrt{\text{Re}\{Z_{Dn}\}}} (V_{dn} - I_{dn} \cdot Z_{Dn})$ | $b_{cn} = \frac{1}{2 \cdot \sqrt{\text{Re}\{Z_{Cn}\}}} (V_{cn} - I_{cn} \cdot Z_{Cn})$ |

S=b/a



For a balanced device, we are not necessarily interested in voltages and currents referenced to ground. Instead, we can define differential and common mode voltages and currents on each balanced port. Likewise, we can also define differential-mode and common-mode impedances.

As with the single-ended case, we can also define normalized power waves on the ports of a balanced device. In this case they are mode-specific. The differential and common-mode voltages and currents defined earlier can be used for this, resulting in normalized power waves having the exact same form as the single-ended case. Only the definitions of “voltage” and “current” are changed.

Mathematically, the differences between conventional single-ended s-parameters and mixed-mode s-parameters are few. Both are defined as ratios of normalized power waves.

Mixed-Mode S-Matrix

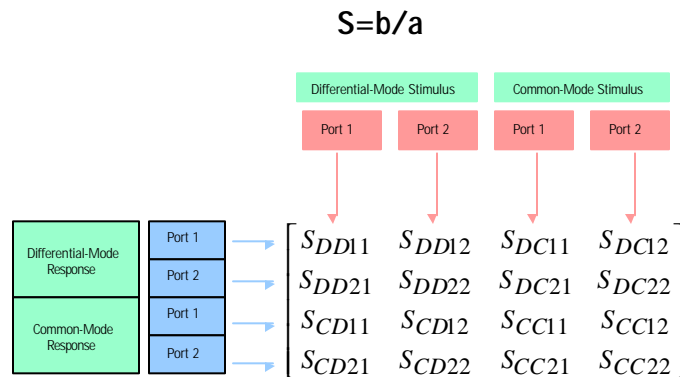

Naming Convention: $S_{\text{mode res., mode stim, port res., port stim.}}$



Again we can take a ratio of all of the possible combinations of response over stimulus for the differential and common-mode normalized power waves to calculate the mixed-mode s-parameters.

A mixed-mode s-matrix can be organized in a similar way to the single-ended s-matrix, where each column represents a different stimulus condition, and each row represents a different response condition.

Unlike the single-ended example, though, in the mixed-mode s-matrix we are not only considering the port, we are also considering the mode of the signal at each port.

The naming convention for the mixed-mode s-parameters must include mode information as well as port information. Therefore, the first two subscripts describe the mode of the response and stimulus, respectively, and the next two subscripts describe the ports of the response and stimulus.

The mixed-mode matrix fully describes the linear performance of a balanced two-port network. To understand the information contained in the mixed-mode s-matrix, it is helpful to examine each of its four modes of operation independently by dividing this matrix into four quadrants.

Mixed-Mode S-Matrix: DD Quadrant

Input Reflection

Reverse Transmission

$$\begin{bmatrix} S_{DD11} & S_{DD12} & S_{DC11} & S_{DC12} \\ S_{DD21} & S_{DD22} & S_{DC21} & S_{DC22} \\ S_{CD11} & S_{CD12} & S_{CC11} & S_{CC12} \\ S_{CD21} & S_{CD22} & S_{CC21} & S_{CC22} \end{bmatrix}$$

Forward Transmission

Output Reflection

Describes Fundamental Performance in Pure Differential-Mode Operation

For a device with two balanced ports, the quadrant in the upper left corner of the mixed-mode s-matrix describes the performance with a differential stimulus and differential response. When the performance of the device is isolated to this specific mode, these four parameters describe the input and output reflections, and the forward and reverse transmissions much in the same way a 2-port s-matrix describes the performance of a single-ended device.

Conceptual View of DD Quadrant

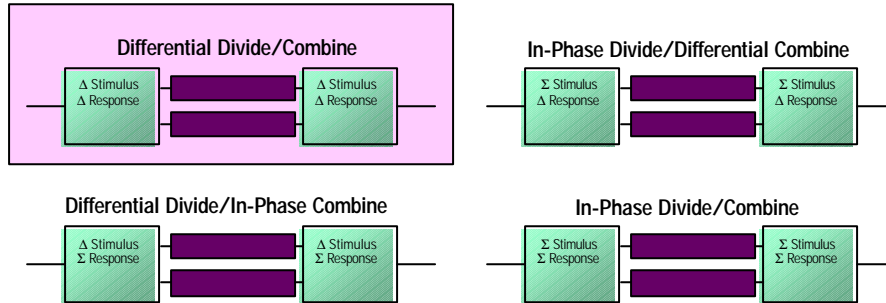

Hybrid Network:

- Divides Signals Differentially
- Combines Signals Differentially
- Is Ideal

The balanced ports can be converted to single-ended ports. An ideal balun will do this, but the performance will be isolated to the differential mode. The s-parameters of the resulting 2-port single-ended network are the s-parameters in the DD quadrant of the mixed-mode s-matrix.

Mixed-Mode S-Matrix: CC Quadrant

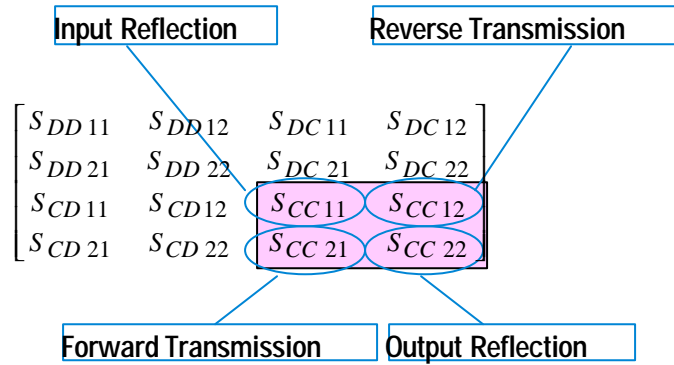

Describes Fundamental Performance in
Pure Common-Mode Operation

For a device with two balanced ports, the quadrant in the lower right corner of the mixed-mode s-matrix describes the performance with a common-mode stimulus and a common-mode response. When the performance of the device is isolated to this specific mode, these four parameters describe the input and output reflections, and the forward and reverse transmissions.

Conceptual View of CC Quadrant

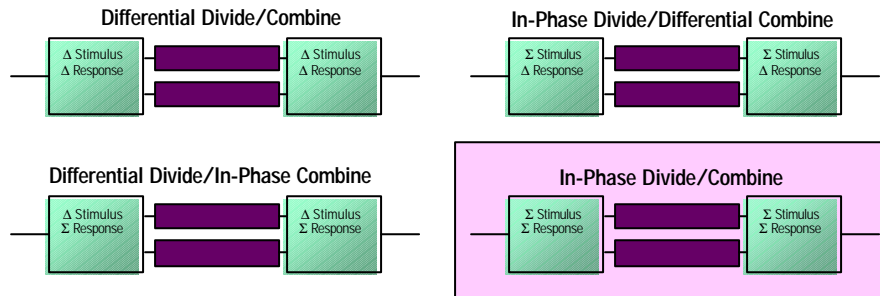

Hybrid Network:

- Divides Signals In-Phase
- Combines Signals In-Phase
- Is an Ideal Power Divider & Combiner

The balanced ports can also be converted to single-ended ports with an ideal power divider/combiner. In this case, the performance will be isolated to the common mode. The s-parameters of the resulting 2-port single-ended network are the s-parameters in the CC quadrant of the mixed-mode s-matrix.

Mixed-Mode S-Matrix: CD Quadrant

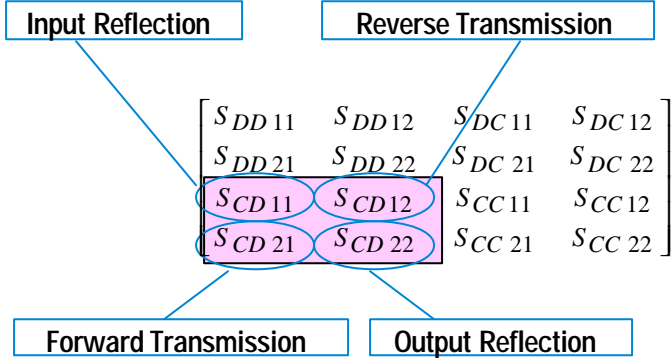

- Describes Conversion of a Differential-Mode Stimulus to a Common-Mode Response
- Terms Are Ideally Equal to Zero with Perfect Symmetry
- Related to the Generation of EMI

The parameters in the lower left corner describe the common-mode response of a device to a differential stimulus. As with the other modes, there are reflection parameters on each port, and transmission parameters in each direction.

In an ideal balanced device that is perfectly symmetrical, there will be no conversion from differential mode to common mode. In that case, all of these terms will be equal to zero. As the device becomes asymmetrical, these terms become larger. Therefore, the mode conversion terms provide a measure of device symmetry.

Why is mode conversion important?

All of the performance benefits of differential circuits assume that the device is symmetrical. The benefits become diminished as the device becomes more asymmetrical.

Differential to common mode conversion is even related to the generation of EMI in a balanced device. The differential mode stimulus becomes converted to common mode, and appears on a ground return. From there it can be radiated as if from an antenna.

Conceptual View of CD Quadrant

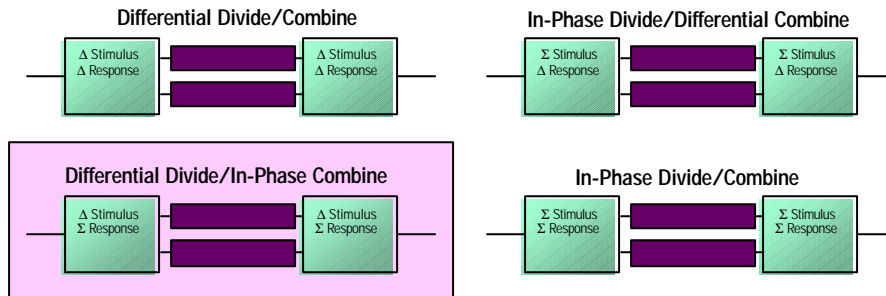

Network:

- Divides Signals Differentially
- Combines Signals In-Phase
- Is Non-Reciprocal

Once again we can convert the balanced port to a single-ended port to understand this mode more conceptually. In this case our network will have to divide the signal differentially as it propagates towards to DUT, and combine signals in-phase as they propagate away from the DUT. Therefore, our network will need to be non-reciprocal in addition to having perfect return loss, insertion loss, balance, and isolation.

Mixed-Mode S-Matrix: DC Quadrant

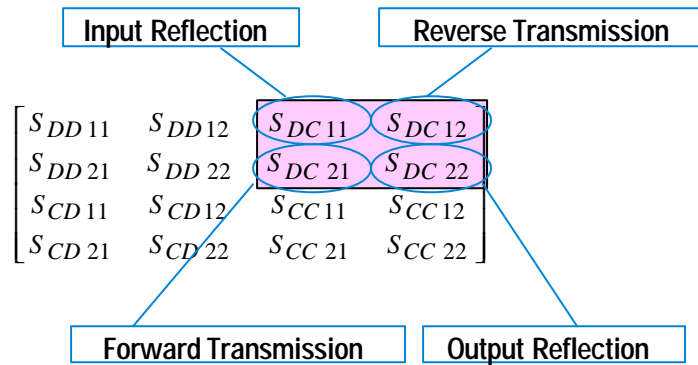

- Describes Conversion of a Common-Mode Stimulus to a Differential-Mode Response
- Terms Are Ideally Equal to Zero with Perfect Symmetry
- Related to the Susceptibility to EMI

Finally, the parameters in the upper right corner describe the differential response of a device to a common-mode stimulus. Again, there are reflection parameters on each port, and transmission parameters in each direction.

In an ideal balanced device that is perfectly symmetrical, there will be no conversion from common mode to differential mode. In that case, all of these terms will be equal to zero. As the device becomes asymmetrical, these terms become larger. Therefore, the mode conversion terms provide a measure of device symmetry.

The same benefits of symmetry apply to this mode as discussed in the CD quadrant.

Where differential to common mode conversion is related to the generation of EMI in a balanced device, the common to differential terms are related to the susceptibility of a device to EMI. Common-mode noise, for example, can become converted to differential mode and degrade the signal-to-noise ratio of the system.

Conceptual View of DC Quadrant

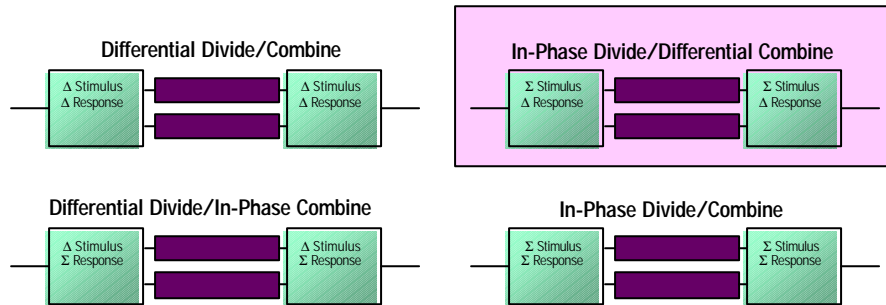

Network:

- Divides Signals In-Phase
- Combines Signals Differentially
- Is Non-Reciprocal

The balanced port can be converted to a single-ended port in this case with a network that divides the signal in-phase as it propagates towards to DUT, and combine signals differentially as they propagate away from the DUT. Once again, our network will need to be non-reciprocal in addition to being ideal.

For propagation in a given direction, a device will not necessarily convert a differential signal to common mode with the same efficiency that it converts a common-mode signal to differential mode. For example, a device can be susceptible to EMI without generating EMI. Therefore, it is important to consider both the CD and the DC quadrants.

Three-Terminal Devices

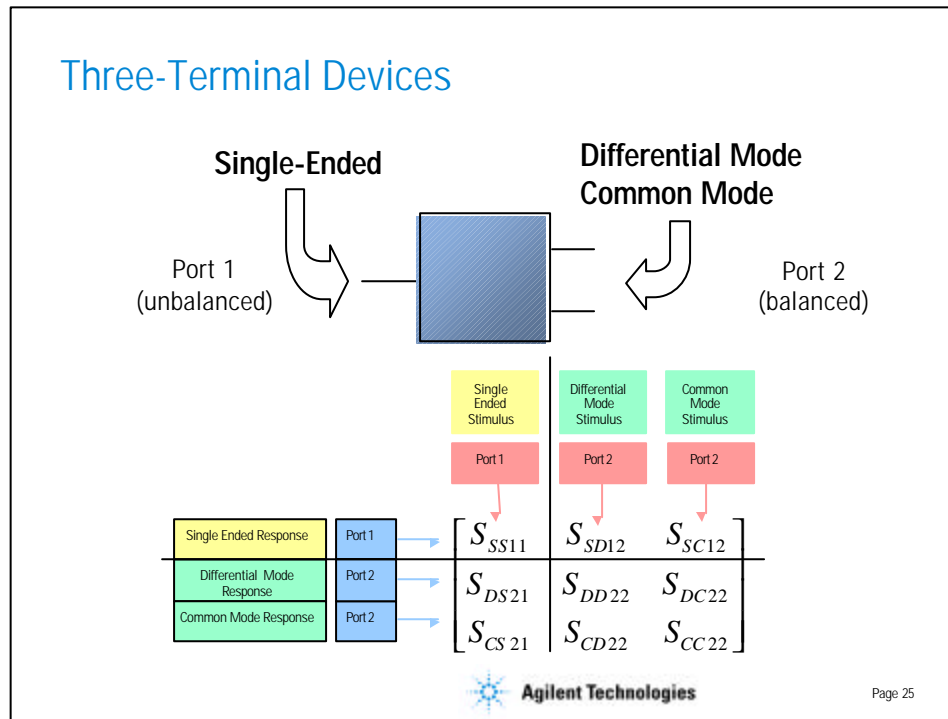

The balanced device that was examined until now has had two balanced ports. A simple extension of the mixed-mode concept can be applied to devices having a combination of balanced and single-ended ports. In this scenario, we need to consider differential and common modes on the balanced ports, and one mode on the single-ended port.

The s-matrix for such a device is again arranged with the stimulus conditions in the columns, and the response conditions in the rows. Notice that two columns and two rows describe each balanced port, and one column and one row describe each single-ended port.

In this case the four parameters in the lower right corner describe the four types of reflection that are possible on a balanced port, the single parameter in the upper left describes the reflection on the single-ended port, and the other four parameters describe the differential and common mode transmission characteristics in the forward and reverse directions.

Hardware Architecture

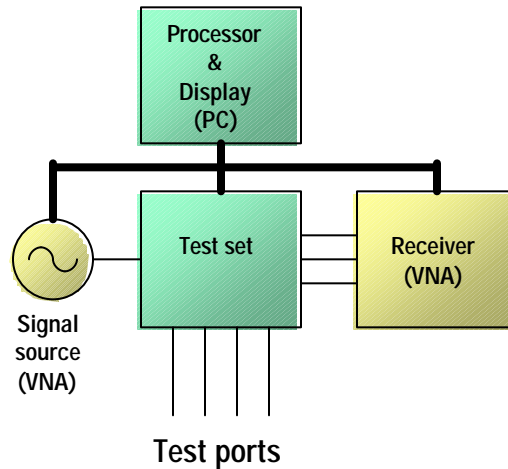

The system that measures balanced devices and display mixed-mode s-parameters, uses a combination of hardware and software from Agilent. A 6 GHz system is available using the 8753 VNA and E8357A PNA, as is a 20 GHz system using the 8720.

The systems augment the Agilent VNA's by expanding the number of test ports from 2 to 4. The hardware configuration is not a switch matrix, but rather forms a true multiport test set that multiplexes into the source and receiver of the VNA.

The hardware increases the number of test ports to four, and the Windows-based software performs a true multiport vector error correction. This combination allows the accuracy of the two-port VNA to be extended to four-port unbalanced and two-port balanced device measurements.

It is important to note that a switch matrix approach is unsuitable for the balanced DUT application because the performance degradation resulting from using a switch matrix is not acceptable.

In this configuration, the VNA is simply providing the source and receiver. The test set hardware provides the interface to the DUT, and the features that are normally part of the analyzer firmware, such as calibration routines, error correction, measurement routines, and user interface features, are built into the Windows-based software.

Configuration

| RF Systems | Microwave Systems |
|--|------------------------------|
| VNA 8753C 8753D (opt. 011) 8753E (opt. 011) 8753ES (opt. 011 or 014) E835x PNA (opt. 015) | VNA 8720ES (opt. H32/H42) |
| Computer Pentium PC or better Windows 95, 98, or NT 1024 x 768 resolution or better 32MB RAM or more IEEE-488 Cards National Instruments (any) HP 82340, HP 82341 | |



Page 27

The 6 GHz system that works with the 8753 uses a test set. The 8753 VNA requires either the delete test set option (011) or the configurable test set option (014).

In the 20 GHz system, the 8720 VNA is augmented with two additional test ports on the hardware that complement the two built-in test ports. The option that provides the correct hardware hooks is H32 for a 3-channel system, or H42 for a 4-channel system.

In both cases the application software runs on a PC with the Windows 95, 98, or NT operating system. Both the test set and the VNA are completely controlled by the Windows-based software over the GPIB.

Complete System



- Complete Measurement with One-Time DUT Connection
- True 4-Port Test Set Hardware
- True 4-port vector error correction
- Accuracy of 2-port Measurement



Page 28

These photos show 6GHz and 20GHz systems that work with the 8753 and 8720 VNA's, respectively. This is a true 4-port measurement system with true 4-port error correction. Designing the systems in this way is essential for obtaining accurate mixed-mode s-parameter data.

Examples

- DUT's
 - 11M Fibre Channel cable
 - 1M Fibre Channel cable
 - 10M Fibre Channel patch cord
 - 1M Fibre Channel patch cord
- Interface to VNA
 - semi-rigid coaxial cables (de-embedded from measurement)
- Analysis:
 - S-parameters (unbalanced & balanced)
 - Time-domain responses (unbalanced & balanced)
 - Eye diagrams
- Reference impedances: unbalanced = 75 Ω , differential = 150 Ω

To further understand mixed-mode s-parameters, we will next examine the measured data of several balanced transmission lines. These devices are all Fibre Channel cables that consist of two balanced pairs, one for sending data in each direction.

We will show how the cable interface was fixtured, and how the effects of the fixture were de-embedded (electrical effects mathematically removed) from the measurement.

The data that is analyzed will be in various representations in the frequency-domain and the time-domain.

Since this is a Fibre Channel cable, the data will be normalized to a reference impedance of 150 Ω differential.

Example #1

11M of Fibre Channel Cable

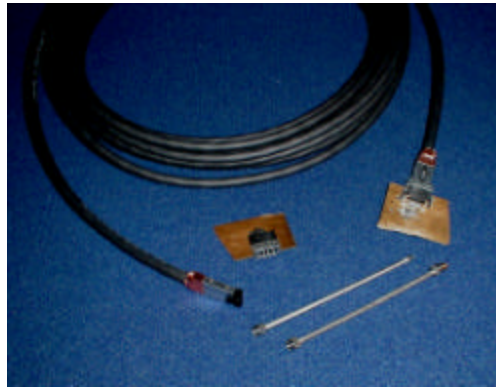

 Agilent Technologies

Page 30

The first device to be considered will be an 11M length of cable. The interface is through SMA connectors attached to short lengths of semi-rigid cable. These semi-rigid cables were characterized to allow them to be de-embedded later.

Mixed-Mode S-Parameters

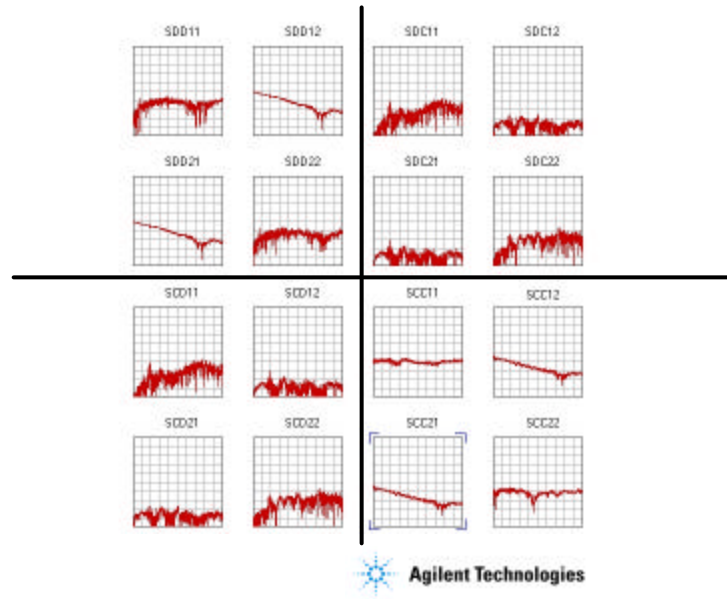

The mixed-mode s-parameters of this cable are shown on this slide. The parameters upper left quadrant describe the behavior in the differential mode. They show a return loss of 20dB at the low end of the band, increasing to about 8dB at the worst point. The loss increases linearly to about 15dB. The common mode return losses are slightly worse, and the loss a little higher.

Arbitrary Reference Impedance

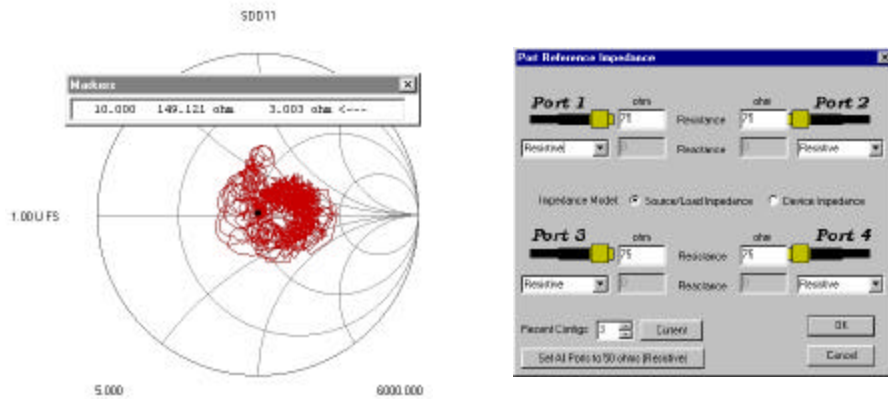

150Ω differential used for Fibre Channel Measurements



The reference impedance has been set to 150Ω differential for this device. When a marker is placed at the Sdd11 display at the low end of the band, the impedance readout of the marker confirms that the impedance of the cable is nominally 150Ω.

Mixed-Mode TDR & TDT

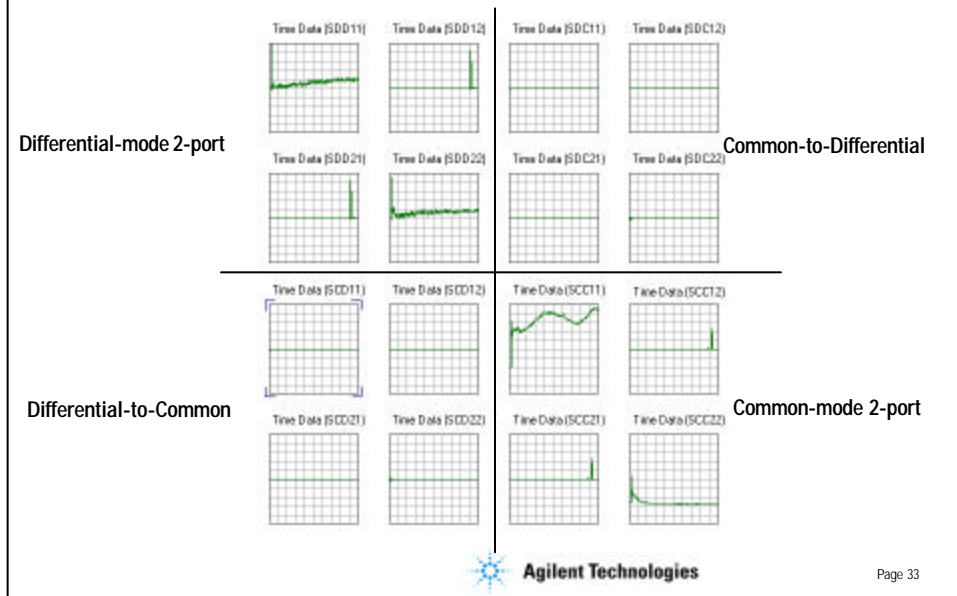

By transforming the frequency-domain data into the time-domain using an FFT algorithm, it is possible to examine the step and impulse responses of the DUT. This can be done on any of the s-parameters, whether they are single-ended parameters, or mixed-mode s-parameters.

The data shown here is the complete time domain representation of the mixed-mode s-matrix. Included in this data are the input and output TDR responses, and forward and reverse TDT responses. These responses can be seen in all four of the operating modes: pure differential, pure common, differential-to-common, and common-to-differential. In this case, we are seeing the impulse responses of the transmission parameters, and the step responses of the reflection parameters.

System Performance

6GHz Measurement Bandwidth

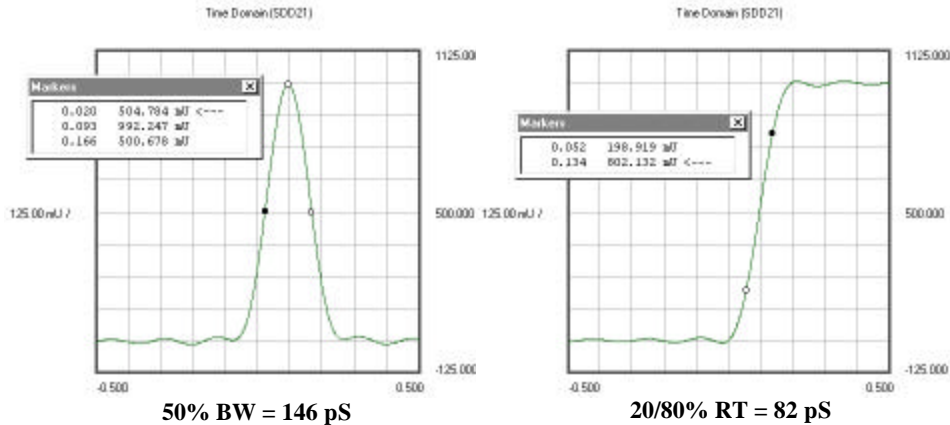

- Also depends of digital filter value
- Inversely proportional to measurement bandwidth



These graphs show the TDT response of the 6GHz system with a through connection (no DUT). This shows the effective impulse width and step rise time. These times are proportional to the maximum measurement frequency, so the pulse width of the 20GHz system is 44pS, and the rise time is 25pS.

The FFT algorithm also performs some filtering. The filtering reduces the side-lobes at the expense of broadening the pulse (slowing the rise time) slightly.

Differential Mode Reflection

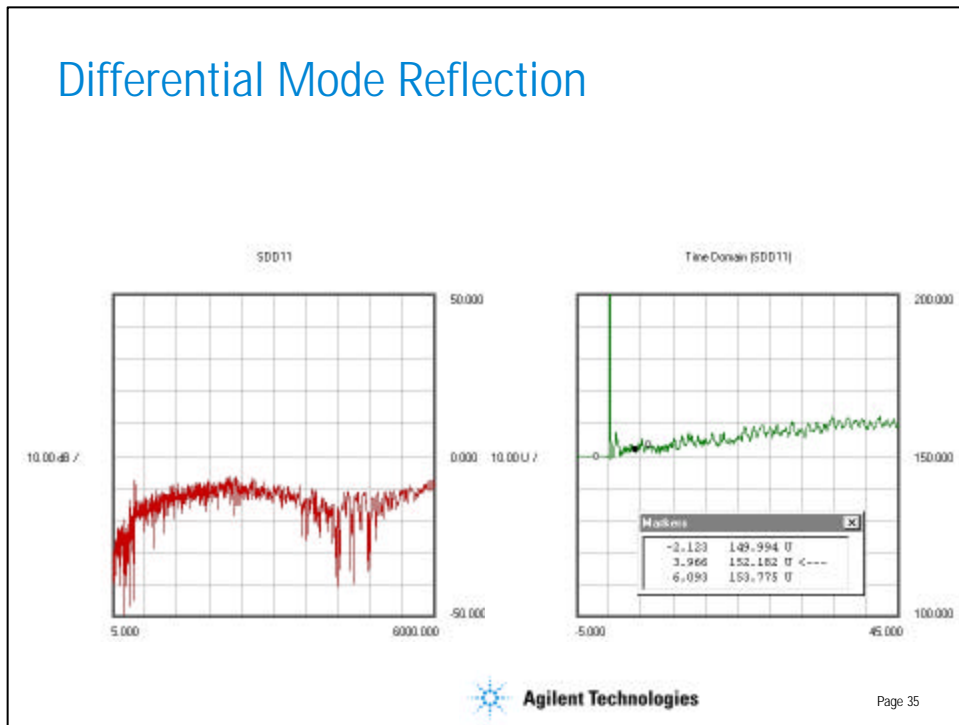

This data shows the differential input reflection performance in the frequency domain and the time domain. The time-domain data is the step response, formatted in ohms on the vertical axis. There is a large discontinuity on the input side as indicated by the spike. This may be responsible for the relatively poor return loss above 1.5GHz.

Differential Mode Reflection (gated)

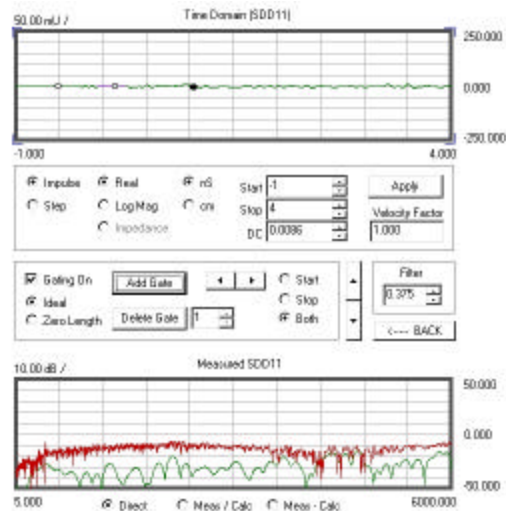

We may want to know what effect the large discontinuity at the input has on the frequency-domain response. The graph at the top of this page shows the time domain response of this device, but with the discontinuity “gated,” or mathematically removed.

The frequency-domain responses are shown in the lower graph. The red trace is the original data, corresponding to the un-gated data. The green trace is the frequency-domain response with the effect of the discontinuity removed. A considerable improvement can be seen across the entire measurement band.

Differential Mode Transmission

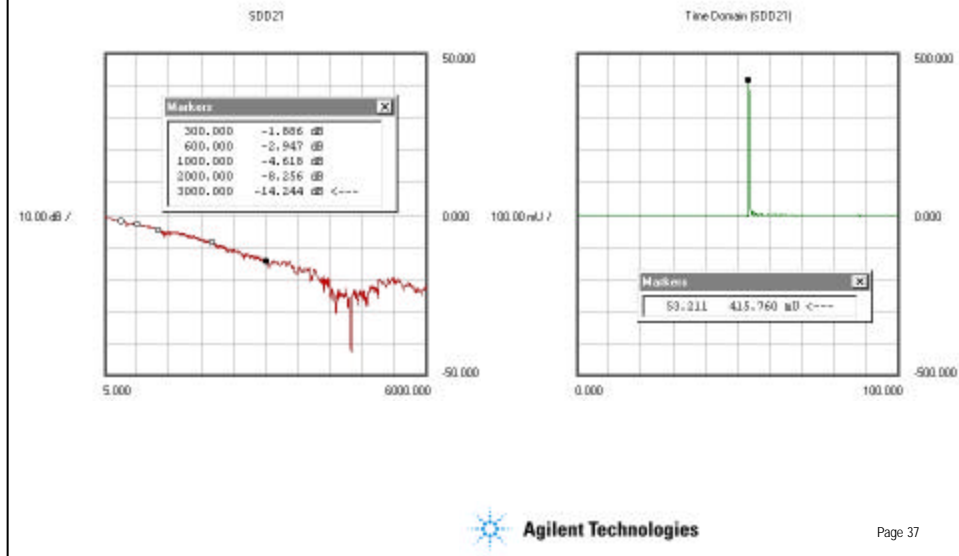

This data shows the differential forward transmission response in the frequency domain and the time domain. The time-domain data is the impulse response. The loss with frequency increases approximately linearly up to about 3 GHz. The group delay is about 53.2 nS.

Single-Ended vs. Differential TDT

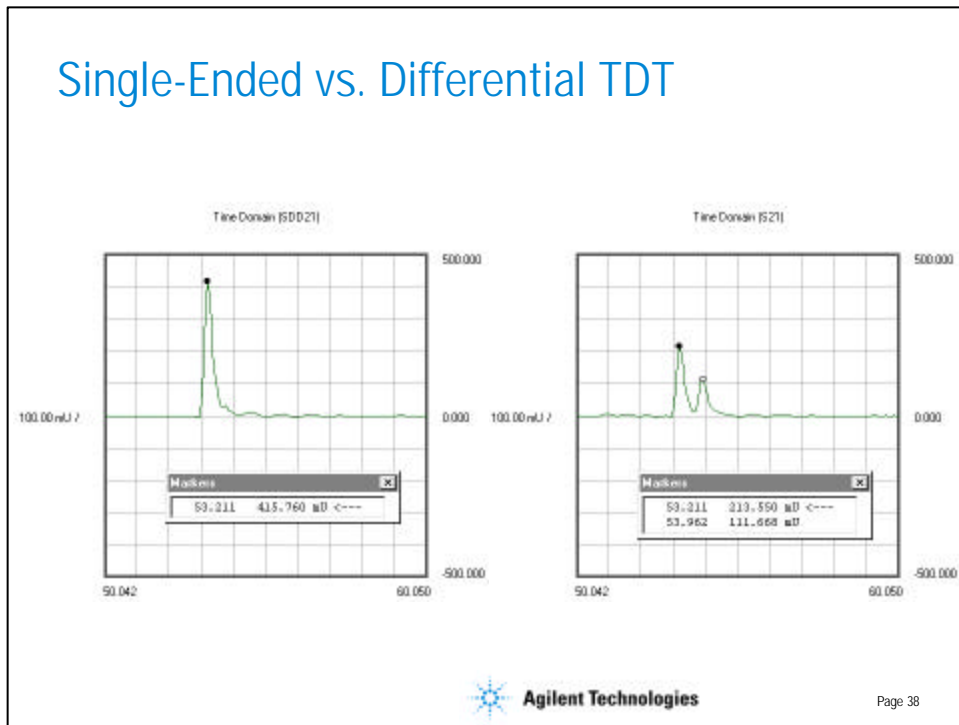

Often engineers will try to characterize the between-pair skew by making two single-ended measurements, one on each side of the pair. This can lead to misleading conclusions.

On the left we again see the differential-mode impulse response with a clear group delay.

On the right we see the single-ended impulse response of just one trace in the balanced pair. There are clearly two peaks in the response that are the result of two modes of propagation that the signal can take. Therefore, what is the single-ended group delay of this device?

Asymmetry

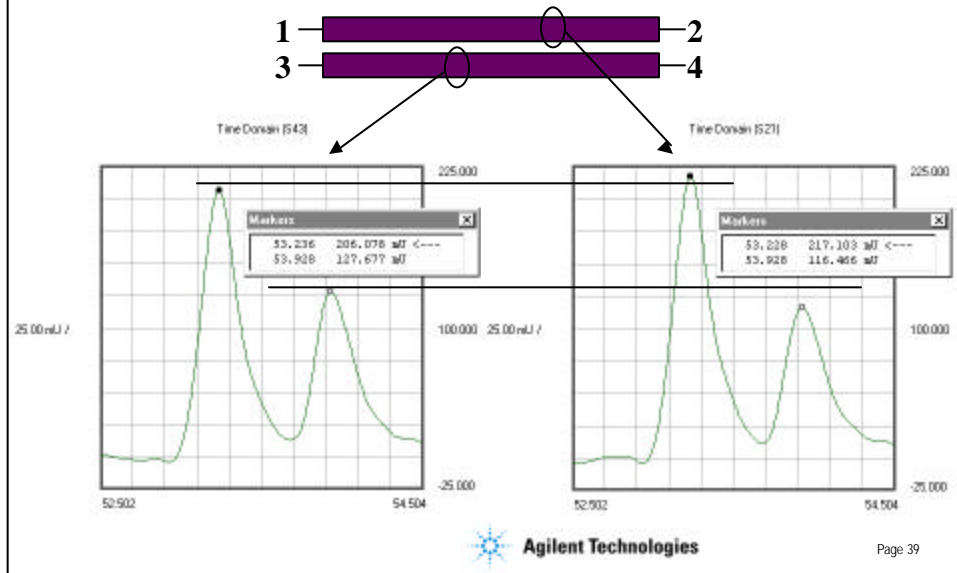

Like any physical device, this one is not perfectly symmetrical. This can be seen by comparing the path from 1-to-2 to that from 3-to-4. The responses look similar, but they are not exactly the same height, and they do not occur at exactly the same times. Therefore, how do we quantify the asymmetry of a balanced device with single-ended measurements?

Mode Conversion

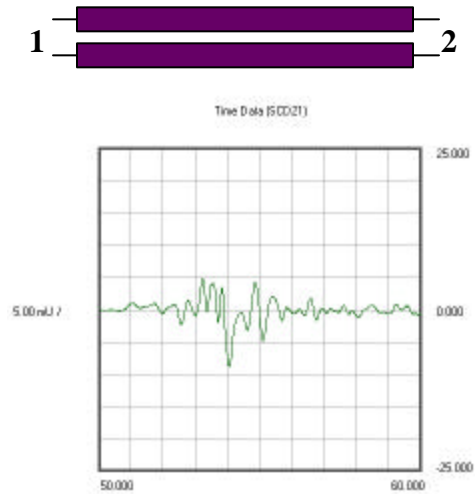

 Agilent Technologies

Page 40

During the review of mixed-mode s-parameters in the frequency domain, we described the mode conversion parameters as being related to the asymmetry. In a perfectly symmetrical device, the mode conversion terms will be equal to zero. We can also examine the mode conversion parameters in the time domain. For example, the Scd21 of this transmission line are shown in this slide.

Coupled Paths

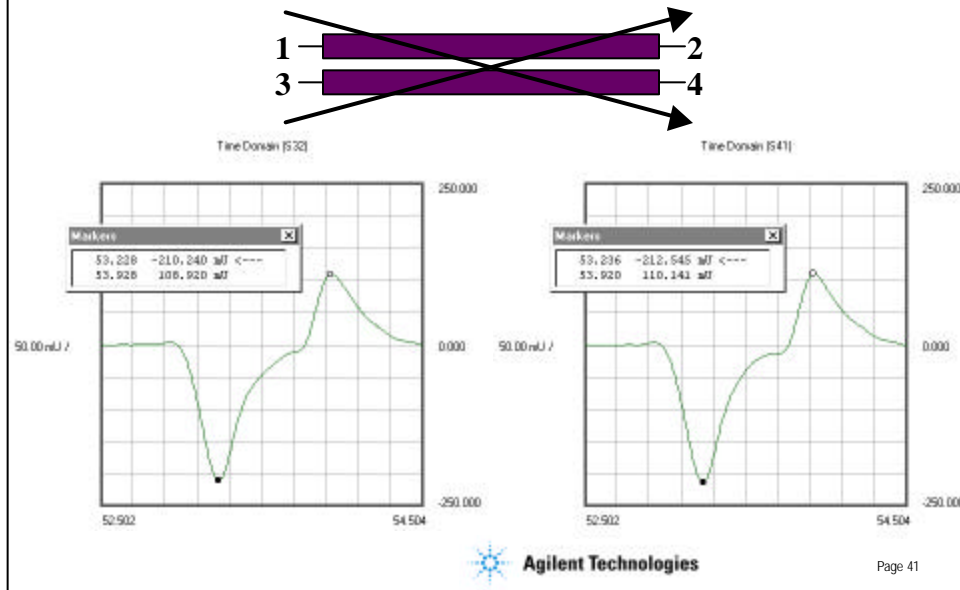

In addition to looking at the impulse responses from 1-to-2 and from 3-to-4, we can also look at the 1-to-4 and the 3-to-2 paths. Those single-ended impulse responses are shown in this slide. A phase reversal of one of the two peaks is clearly observed. This gives rise to one value for group delay in differential mode, and another value of group delay in common mode. This is because the first peak adds in differential mode and cancels in common mode, and the second peak cancels in differential mode and adds in common mode.

Differential-Mode, Simplex Eye Diagrams



| Drive | | Output | | Parameter | Comments |
|-------|------|--------|------|-----------|-----------|
| Port | Mode | Port | Mode | | |
| 1 | Diff | 2 | Diff | Sdd21 | Thru path |

A Fibre Channel cable has two balanced pairs, one for sending data in each direction. The frequency domain measurements described here will fully describe the DUT provided the proper analysis is performed. So far we have concentrated on a single pair operating in one mode at a time. The next few slides will concentrate specifically on a single pair operating in differential mode.

11M Wire: Different Data Rates

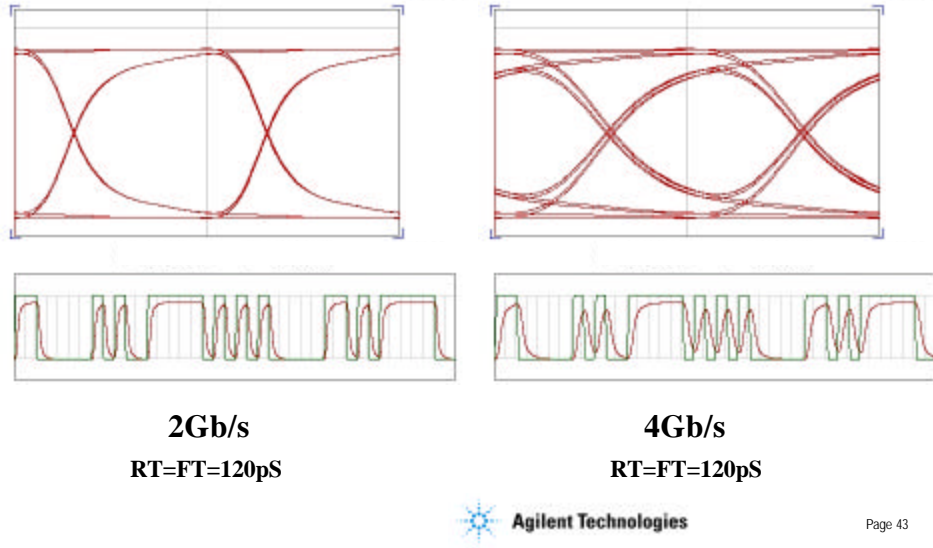

The graphs on the left show the result of using the differential mode s-parameter data and generating an eye diagram. The driving function is a data rate of 2 Gb/s with rise and fall times of 120 pS, shown as the green trace below the eye. The resulting output waveform is overlaid in red, shifted in time to be synchronized with the input waveform. This output waveform is then used to generate the eye diagram above.

On the right is the same type of information, but at a data rate of 4 Gb/s. As expected, the eye has collapsed compared to the data on the left.

11M Wire vs. 10M Assembly

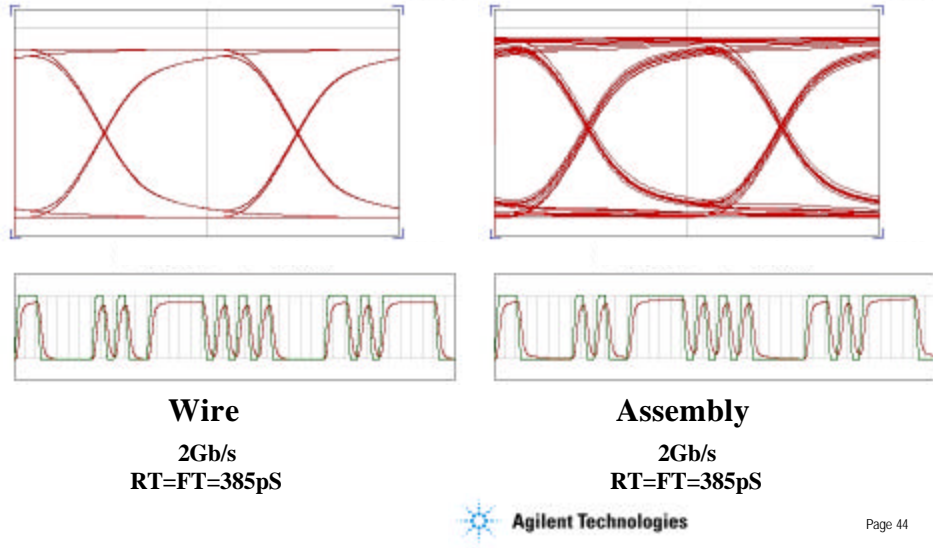

This graph compares a length of cable with de-embedded SMA connectors with a patch cable consisting of approximately the same length of cable plus two high speed connectors. Comparing these diagrams clearly shows a degradation in the eye diagram resulting from the electrical performance of the connectors.

1M Assembly vs. 10M Assembly

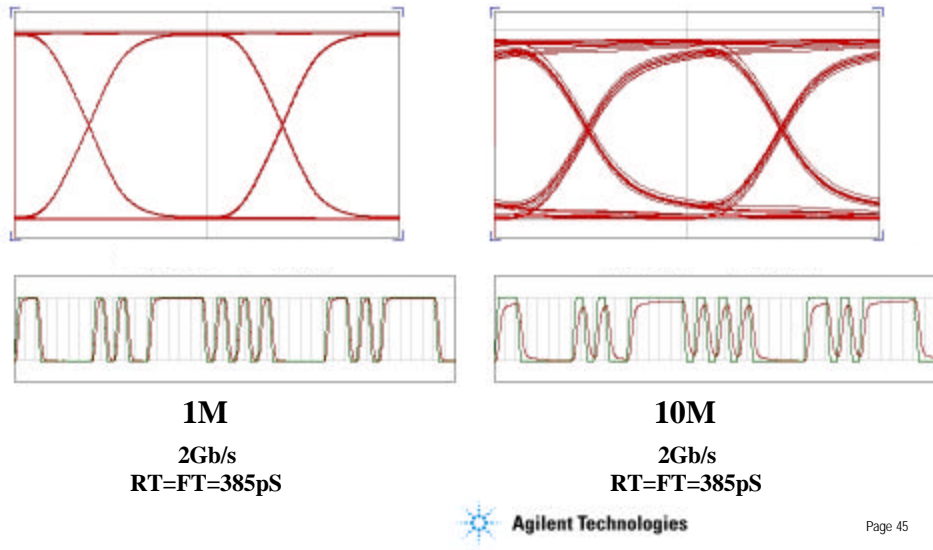

This slide again looks at patch cords, but of two different lengths. One is 1 M long and the other is 10 M long. Clearly the shorter device degrades the signal less than the longer device.

“What If ...” Analysis



One of the major differences between the TDR and the VNA for characterizing balanced devices is that the TDR provides scalar data, while the VNA provides vector data. Having vector data allows more powerful capabilities, such as better error correction, and features such as de-embedding, arbitrary reference impedance definitions, and reference plane rotation (or port extension).

This example shows how the effect of phase skew can be examined using reference plane extension.

Phase Skew on 11M Cable

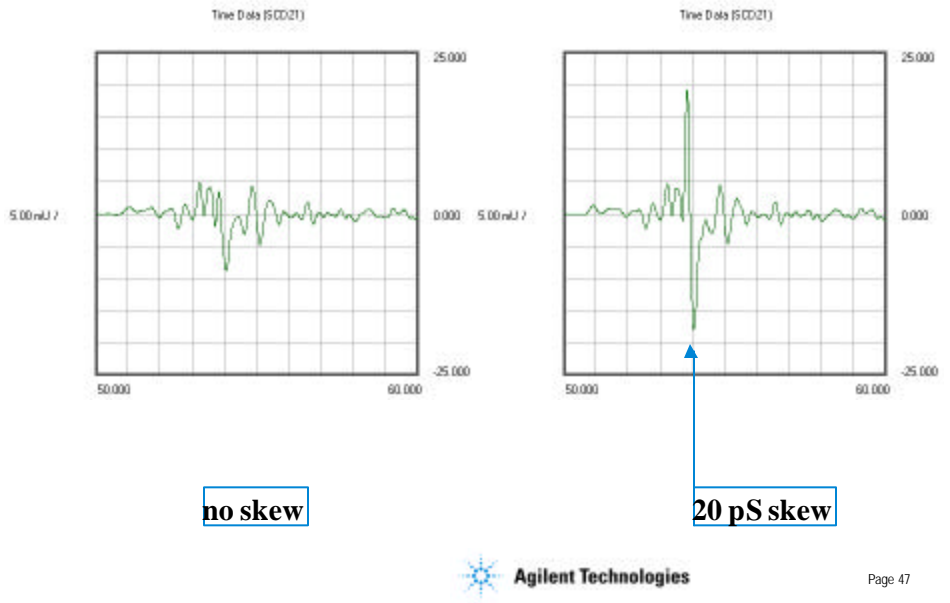

As described earlier, the mode-conversion terms can be used to help determine the cause of asymmetry in a DUT. Even a slight asymmetry can be observed in the time domain. For example, the graph on the left shows the Scd21 parameter of the 11M Fibre Channel cable. If a phase skew of only 20 pS is introduced, the result can be clearly observed, as shown in the graph on the right.

Phase Skew on 10M Assembly

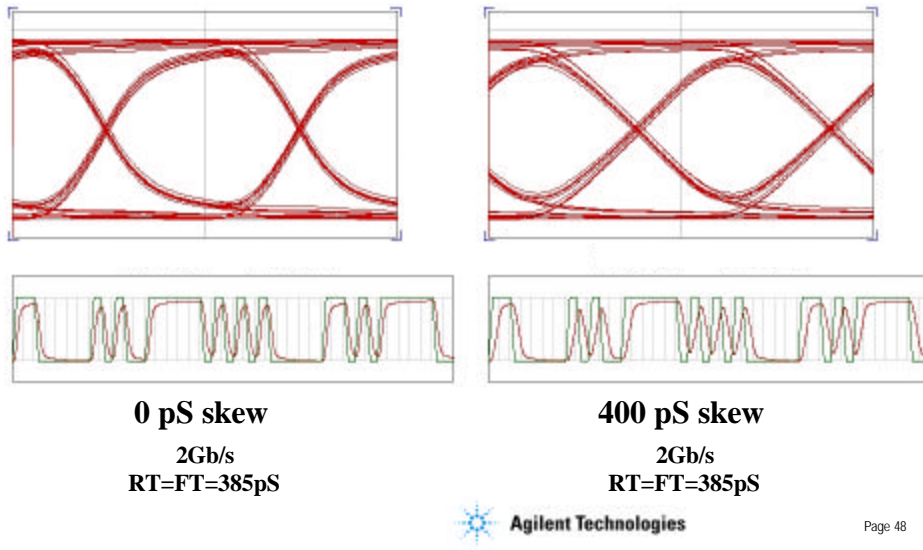

Of course the skew also has an effect on the eye diagram. On the left is the 10 M length of patch cord we have been examining. On the right is the same device with same driving function, but a skew of 400 pS has been introduced. As expected, the resulting eye has begun to collapse.

De-Embedding

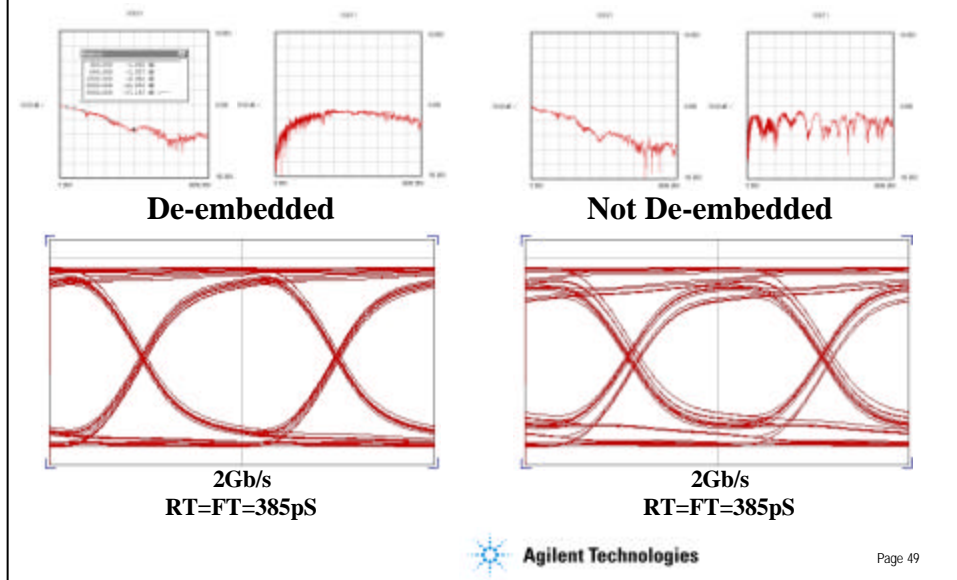

Another of the advantages of vector data is the ability to de-embed. This slide shows a comparison of data with and without de-embedding of the interconnecting lines.

The forward transmission versus frequency is in the upper left, with the input return loss is next to it. Below these two curves is the corresponding eye diagram.

Clearly, the interconnect can significantly alter the measured data and should not be neglected. Therefore, careful de-embedding can yield more accurate data.

Mixed-Mode, Simplex Eye Diagrams

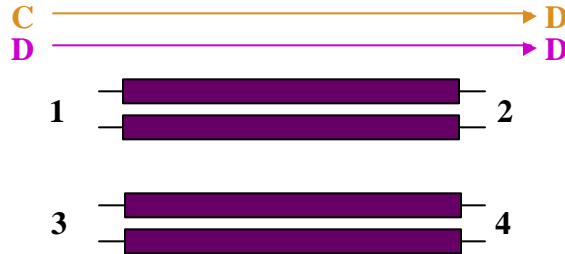

| Drive | | Output | | Parameter | Comments |
|-------|------|--------|------|-----------|------------------------|
| Port | Mode | Port | Mode | | |
| 1 | Diff | 2 | Diff | Sdd21 | Thru path |
| 1 | Comm | 2 | Diff | Sdc21 | Thru + mode-conversion |

Until now, all of the data we have considered has been in a pure differential mode. We know that in a physical system there is always a common mode present, and that our DUT will have some asymmetry that will convert the common mode to differential mode. To analyze this situation we can examine the appropriate mode-conversion parameter, and look at the composite response in exactly the same way. The VNA-based tool gives us a way of discriminating between these two mechanisms. In contrast, a TDR can show only a composite response, and the results will also include the inevitable effect of jitter in the source.

Mixed-Mode, Duplex Eye Diagrams

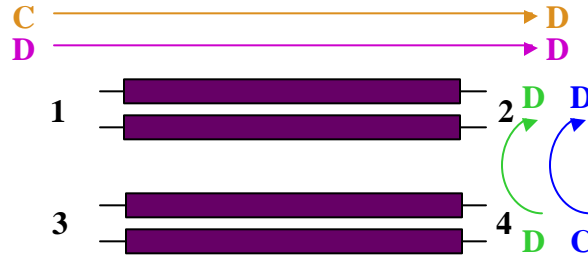

| Drive | | Output | | Parameter | Comments |
|-------|------|--------|------|-----------|------------------------|
| Port | Mode | Port | Mode | | |
| 1 | Diff | 2 | Diff | Sdd21 | Thru path |
| 1 | Comm | 2 | Diff | Sdc21 | Thru + mode-conversion |
| 4 | Diff | 2 | Diff | Sdd24 | NEXT path |
| 4 | Comm | 2 | Diff | Sdc24 | NEXT + mode-conversion |

In the case of a Fibre Channel cable, this device is normally operated in a full duplex mode. For example, it may be driven from port 1 at the same time it is being driven from port 4. Both sources will give rise to an output on port 2, depending on the amount of near-end crosstalk in the cable. With both the through and the NEXT we need to consider the D-to-D and the C-to-D components. Therefore there are a total of four terms that will make up the composite response. Again, all of these can be examined individually. Perhaps more significant, though, is that a second signal generator is not needed to perform this test.

Frequency to Time: Limitations

- Assumption that DUT has linear properties
 - but can be active, passive, reciprocal, non-reciprocal
- Measurement Bandwidth
 - spatial resolution determined by maximum frequency
 - effective rise time limited by maximum frequency
 - 6GHz → appx. 146pS pulse width or 82pS rise time
 - 20GHz → appx. 44pS pulse width or 25pS rise time
- Aliasing
 - measurement range limited by frequency step size
 - 5MHz → 50nS or 10M (assuming 70% velocity factor)
- Other
 - generally requires $F_{\text{start}} = F_{\text{step}}$ but a work-around exists for t-lines



The only assumption that is made about the DUT is that it has linear properties. In other words, its characteristics are independent of the amplitude of the signal. However, the device can be symmetrical or asymmetrical, active or passive, and reciprocal or non-reciprocal.

The measurement bandwidth determines the effective pulse width of the impulse, and effective rise time of the step responses. For example, measuring to 6 GHz in the frequency domain corresponds to a pulse width of approximately 146 pS and a rise time of approximately 82 pS. Measuring to 20GHz decreases these to 44 pS and 25 pS, respectively.

For accurate data in the time domain, it is important to consider the effects of aliasing. Avoiding aliasing requires the use of smaller step sizes as the DUT becomes electrically longer. For example, a 10 M long cable has a delay of about 50 nS. To avoid aliasing a step size no larger than 5 MHz is required. A 1 M cable can be measured with a 50 MHz step size.

The FFT algorithm requires equally spaced points in the frequency domain. These means that the step size must be equal to the start frequency. However, a work-around exists for devices that are well-behaved at lower frequencies, such as transmission lines.

Conclusion

- **No Baluns** - that degrade accuracy, limit visible modes
- **No Pads** - that degrade accuracy in transmission, eliminate ability to measure reflections, reduce dynamic range
- **No need to re-measure DUT to analyze under different conditions**
- **Single calibration** - can be done electronically
- **Single fixture** - can be de-embedded
- **Isolate DUT performance from source jitter**
- **System FULLY characterizes device**
- **Provides a variety a ways to visualize performance**

| Mode | Type | Direction | Domain |
|--------------|--------------|-----------|-----------|
| unbalanced | transmission | forward | frequency |
| differential | reflection | reverse | time |
| common | | | eye |
| c-to-d | | | |
| d-to-c | | | |



We have shown that VNA's are not just for single-ended RF and microwave devices anymore. Measurements of components for high speed balanced applications can be made without the need for baluns or matching pads for measuring non-standard impedances.

A single measurement is comprehensive and does not require reconfiguration of the measurement set-up or re-measurement of the DUT to take an entire set of data.

A single vector error corrected calibration is used. The resulting vector data provides a number of advantages, including the ability to de-embed, transform impedance, change reference planes, and more.

The superior accuracy of the system does not require a balanced source. Therefore, the associated jitter does not degrade the accuracy of the measurement.

Using s-parameters will comprehensively characterize the DUT. The analysis allows the data to be examined as an unbalanced device, or in any of the four balanced modes. It can be examined in transmission and reflection, and in the forward and reverse directions.

Historically, the type of data provided by the VNA was not the best format for devices used in data communication applications. It is possible, though, to look at the information in the frequency domain, the time domain, as eye diagrams, or even using other representations or models.